

Drone direction estimation: phase method with two-channel direction finder

Indira Kozhabayeva¹, Assel Yerzhan¹, Pavel Boykachev², Zhanat Manbetova³, Manat Imankul⁴,
Builou Yauheni², Andrey Solonar⁵, Pavel Dunayev³

¹Department of Telecommunication Engineering, Institute of Communications and Space Engineering, Non-profit Joint Stock Company Almaty University of Power Engineering and Telecommunication named Gumarbek Daukeev, Almaty, Republic of Kazakhstan

²Department of Tactics and Weapons of Radio Engineering Troops, Faculty of Air Defense, Military Academy of the Republic of Belarus, Minsk, Republic of Belarus

³Department of Radio Engineering, Electronics and Telecommunications, Faculty of Energy, Saken Seifullin Kazakh Agrotechnical Research University, Astana, Republic of Kazakhstan

⁴Department of Radio Engineering, Electronics and Telecommunications, L.N. Gumilyov Eurasian National University, Astana, Republic of Kazakhstan

⁵JSC “KB Radar” – Managing Company of “Radar Systems” Holding, Minsk, Republic of Belarus

Article Info

Article history:

Received Dec 18, 2023

Revised Dec 18, 2023

Accepted Jan 9, 2024

Keywords:

Antenna system

Averaging of bearing estimates

Bearing estimation algorithm

Sliding buffer

Unmanned aerial vehicle

ABSTRACT

This scientific article presents a block diagram of a two-channel radio direction finder that effectively uses the phase method to determine the direction of the signal source. The main attention is paid to the mathematical model of the formation of the cardioid radiation pattern of biconical antennas, which have unique directivity characteristics. These features significantly affect the accuracy and reliability of the bearing determination process. The developed algorithm aims to accurately determine the direction of motion of an unmanned aerial vehicle, especially in the context of a two-channel radio receiver and a five-element antenna system. This antenna system provides unique capabilities for increased resolution and directional accuracy. The article also touches on the issue of software implementation of the developed algorithm, which is aimed at increasing the number of generated bearing estimates in conditions of limited time for observing an unmanned aerial vehicle. Thus, the proposed method is of interest in the field of precision direction finding in the context of small unmanned vehicles.

This is an open access article under the [CC BY-SA](https://creativecommons.org/licenses/by-sa/4.0/) license.



Corresponding Author:

Assel Yerzhan

Department of Telecommunication Engineering, Institute of Communications and Space Engineering, Non-profit Joint Stock Company Almaty University of Power Engineering and Telecommunication named Gumarbek Daukeev

Almaty, Republic of Kazakhstan

Email: asel.yerzhan@inbox.ru

1. INTRODUCTION

At the present stage of the evolution of unmanned aerial vehicles (UAVs), they are successfully integrated into various fields, including transportation [1]–[3], territory security [4]–[6], agriculture, and medicine [7]–[9]. In the military field, UAVs are used for reconnaissance, strike operations, cargo transportation, target designation of other weapons, and autonomous missions by programming [10]. With the increase in the use of UAVs, the need for means to counter their actions in limited areas has also increased. Currently, the most effective method of counteraction is the use of electronic jamming means. The process of countering UAVs begins with detecting the fact of their flight using electronic reconnaissance

equipment. This includes identifying the signal and frequency parameters of radio control and data transmission channels, as well as issuing target designations as shown in Figure 1. In light of this, a current direction of scientific research is the development of proposals for the creation of advanced electronic reconnaissance equipment capable of detecting and determining the coordinates of UAVs with subsequent transmission of the received radar information to the end user.

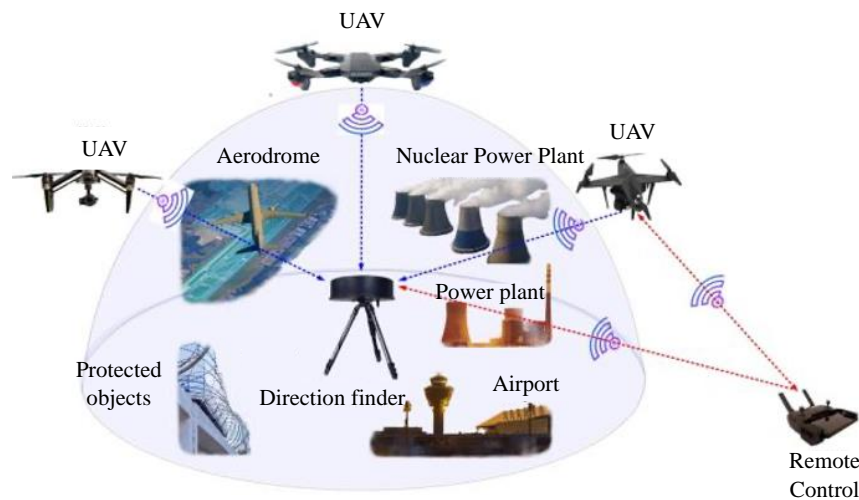

Figure 1. An example of the possible impact of a UAV on cover targets

The purpose of this paper is to develop a highly efficient algorithm designed to determine the direction of an UAV under dual-channel phase direction finder conditions. The main ambition is to create an algorithm that is capable of providing an increased number of accurate bearing estimates in situations of limited UAV observation time. This research aims to develop a method that will be most effective in a two-channel phase direction finder environment, which is critical in the field of UAV position estimation. The algorithm strives to provide high accuracy in generating bearing estimates, even with limited time resources for observing the object. This is essential for the effective use of direction finding in situations [11] that require fast and accurate determination of the direction of the UAV. Therefore, the main objective of the paper is to create a state-of-the-art algorithm specifically tailored for dual-channel phase direction finders to provide accurate and high-quality bearing estimates under time-constraint conditions. This software part is a key element for the successful implementation of the method in real operating conditions. The overall context of the article provides a deep understanding of not only the technical aspects associated with the structure and algorithm but also their practical application, making the work relevant and promising in the field of unmanned navigation and radio direction finding.

Babak *et al.* [12] present examples of the application of the developed models and measures on a circle to study cyclic signals in various fields. The object of study is the phase shift between cyclic signals, with special attention paid to the transition to periodic signals, including harmonic ones. Solutions to the problems of accurately measuring the thickness of materials with high absorption of the ultrasonic echo pulse are considered. The work demonstrates the high probability of detecting information signals in conditions of additive noise using selective circular statistics the length of the resulting vector. A method for processing the results of multiscale phase measurements based on numerical systems of residual classes in phase rangefinders and direction finders is emphasized. Jasim *et al.* [13] discuss the challenges associated with radio frequency spectrum management for UAVs, with a focus on ensuring safe operation, efficient spectrum use, and compatibility with existing wireless networks. They note that current spectrum management schemes have limitations in the context of dynamic UAV networks that require adaptive solutions and robust schemes to ensure uninterrupted and reliable service. The article offers an overview of spectrum management for UAV operations, identifying designs that suit the characteristics of UAVs and ensuring safe and efficient use of the radio frequency spectrum. Catapano *et al.* [14] provides a comprehensive overview of the current state of the art in non-contact ground sensing radar (GPR) technology. In operation, microwave tomography (MWT) is proving to be a very flexible tool to address these challenges. Experimental examples concerning different types of contactless GPRs are presented to validate the effectiveness of MWT when combined with signal-filtering procedures. Noviello *et al.* [15] presented a comprehensive review of the current status and

challenges associated with radar imaging from UAVs, which has attracted enormous interest due to its practical implications. First, a description of the available prototypes is provided in terms of radio technologies, UAV platforms, and navigation control devices. The paper then examines the major issues affecting the performance of radar education systems using UAVs, such as controlling the UAV platform during flight to collect high-quality data, the need to provide accurate platform position information in terms of wavelength, and mitigating interference and other electromagnetic influences.

2. METHOD

This paper covers the development of a direction finder with certain technical characteristics. The emphasis is on creating a device with low cost, compact weight and size parameters, ease of implementation, energy efficiency, and providing the necessary accuracy of bearing measurement. The research results confirmed the success of the development of a phase direction finder, which is based on a two-channel LimeSDR transceiver with built-in analog-to-digital and digital-to-analog converters, operating in the frequency range from 100 kHz to 3.8 GHz. The need for efficient signal processing [16], [17] in conditions of a limited number of processing channels forced the introduction of sequential scanning of space through electronic scanning of the antenna radiation pattern (ARP) with a certain angular velocity. In this configuration, the direction of the UAV is expressed by the phase shift of the envelope of the received signal relative to the reference point, which corresponds to establishing the orientation to the North. Taking into account these technical features, the structure of a two-channel phase direction finder with amplitude modulation [18] of the signal is a complex device that meets the high requirements [19] for modern electronic intelligence systems, as described in previous works [20], [21]. The appearance of the system shown in Figure 2 reflects not only functional efficiency but also its compliance with current norms and standards in this area.

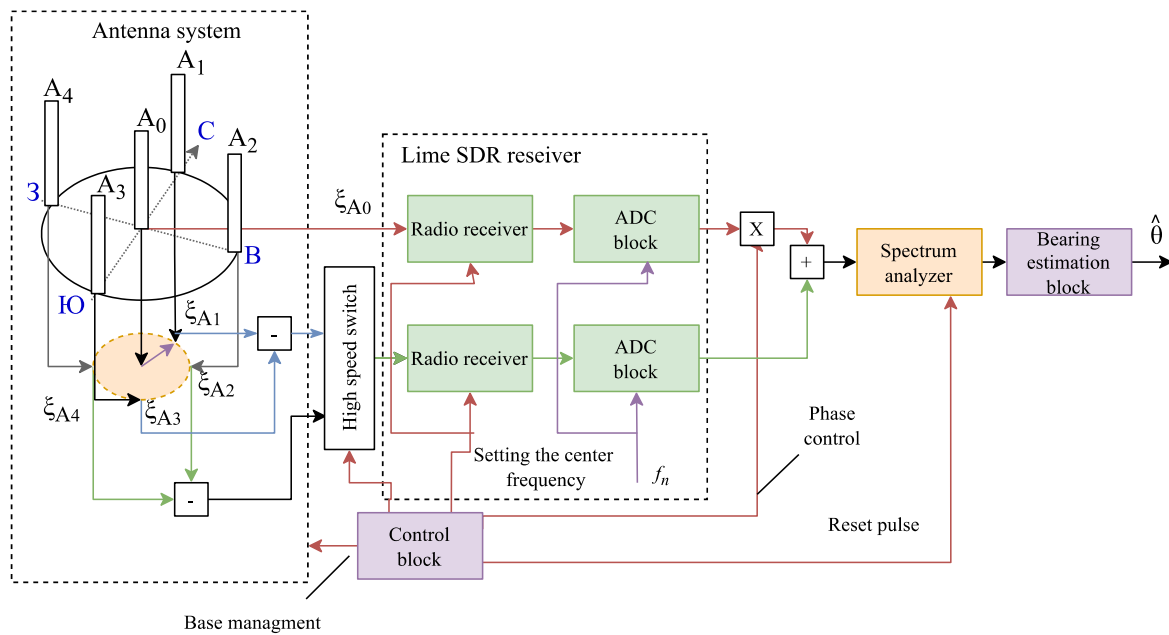

Figure 2. Block diagram of a two-channel phase direction finder

The structure of this radio direction finder implements an integrated sum-difference processing algorithm that performs sequential switching of antenna elements (AE) using a high-speed switch organized in a circle. This algorithm is a key element of space scanning and can provide high accuracy in determining the direction of a UAV. The unique features of cardioid pattern generation received signal processing, and UAV bearing estimation calculations will be analyzed in detail in subsequent sections. These features play an important role in ensuring the effectiveness of a direction-finding system, where taking into account the geometric and phase characteristics of the antenna system is critical to the accuracy of measurements. The antenna system (AS) of this direction finder is based on two orthogonal [22] direction-finding pairs (DF) [23], oriented in the north-south and east-west directions. Each pair consists of two biconical antennas with

broadband characteristics [24] and spaced apart from each other by a distance of $2d$ as shown in Figure 3. This configuration is designed to solve the problem of detection and disambiguation in determining the direction of a UAV [25]. Additionally, an omnidirectional (isotropic) antenna A_0 is installed at the center of the antenna system, which contributes to the effective detection and resolution of uncertainty in the central part of the antenna system. This structure is aimed at increasing the accuracy of bearing determination and effectively solving the problem of radio direction found in difficult operating conditions.

Let us consider the mathematical model of the formation of the resulting cardioid pattern, presented in Figure 3. The difference in the wave path from the antenna and (direction to “north” and “south”) to point will be $\Delta r_{n(s)0} = d\cos\theta$, which corresponds to the phase difference $\Delta\varphi_{n(s)0}$. The phase difference between antenna A_2 and A_4 (direction to “east” and “west”) and $A_0 - \Delta\varphi_{e(w)0}$ (1):

$$\Delta\varphi_{n(s)0} = 2\pi d\cos\theta/\lambda \text{ and } \Delta\varphi_{n(w)0} = 2\pi d\sin\theta/\lambda \tag{1}$$

where λ is the wavelength. In this case, the electromotive force (EMF) induced in the PP antennas will look like in Figure 3:

$$\Delta\varphi_{n(s)0} = 2\pi d\cos\theta/\lambda \text{ and } \Delta\varphi_{n(w)0} = 2\pi d\sin\theta/\lambda \tag{2}$$

$$\xi_{A_1(A_3)}(t) = E_h e^{j(\omega t \pm \Delta\varphi_{n0})} \text{ and } \xi_{A_2(A_4)}(t) = E_h e^{j(\omega t \pm \Delta\varphi_{y0})} \tag{3}$$

where is the amplitude of the signal received by the AE, ω is central frequency of the radio signal, t is time. The amplitude of the difference voltages of the “north-south” PP $\xi_{\Delta 13}(t)$ (4) is proportional to the cosine, and the “east-west” PP $\xi_{\Delta 24}(t)$ is proportional to the sine of the angle of arrival of the wave θ as shown in Figure 3.

$$\xi_{\Delta 13}(t) = U_m \cos \theta e^{j(\omega t + \pi/2)} \text{ and } \xi_{\Delta 24}(t) = U_m \sin\theta e^{j(\omega t + \pi/2)} \tag{4}$$

where U_m is the amplitude of the difference voltage. To form a cardioid pattern $g_{\Sigma}(\theta) = 1 + \cos(\alpha - \theta)$ as shown in Figure 3, for example, in the north direction ($\alpha = 0^\circ$), the difference signal PP $\xi_{\Delta 13}(t)$ is summed with the AE signal ξ_{A_0} (5), adder as shown in Figure 2.

$$\xi_{\Sigma}(t) = \xi_{A_0}(t) + 0.5\xi_{\Delta 13(24)}(t). \tag{5}$$

In this case, the formation of a cardioid is ensured if conditions (3), (4), and (5) are met:

- the amplitudes of the signals of the central A_0 and PP $A_{1(3)}$ AE are equal ($\xi_{A_0} = \xi_{A_1} = \xi_{A_3}$);
- the initial phases of the signals of the central A_0 and the first A_1 AE PP are equal to ($\varphi_{A_0} = \varphi_{A_1}$);
- the initial phases of the signals of the central and second A_3 AE PP differ by π ($\varphi_{A_0} - \varphi_{A_3} = \pi$).

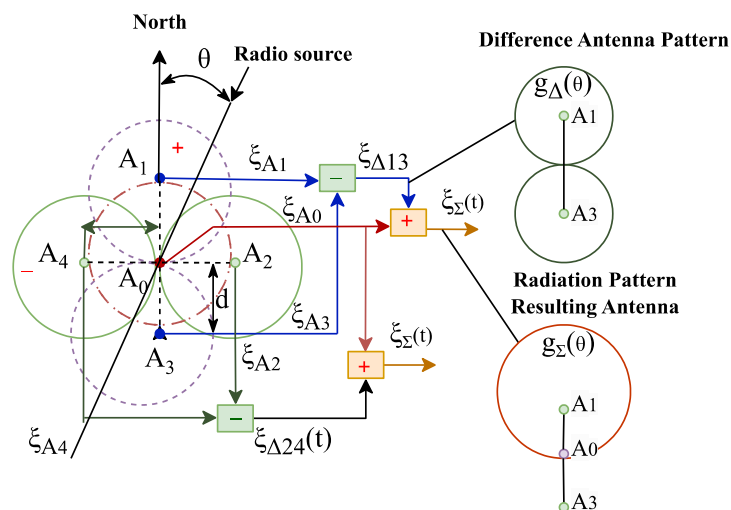

Figure 3. Explanation of the principle of formation of the difference and resulting patterns

The use of a two-channel LimeSDR transceiver requires the use of a combined connection to the input circuit of the PP difference voltage receiver. Given this, the PP difference signals are connected to the second channel of the receiver through a high-speed switch controlled by a microcontroller (4), (5). The AE switching frequency of kHz, provided by a high-speed switch, makes it possible to generate a minimum of 5–7 bearing estimates per contact with the UAV with the shortest duration of the UAV control channel signal ($T_{0ky} = 500$). The central AE signal is fed to the input of the first channel of the LimeSDR transceiver, which is used to solve the problems of detecting UAVs and forming the resulting cardioid pattern. Thus, the directional properties (DNA) of the antenna system are ensured through the sum-difference processing of the received signal with sequential high-speed AE switching. This antenna system has minimal weight and size characteristics and is represented by two PPs oriented in the cardinal directions (three-dimensional surrounding space) and one AE located in the center. The design of the AE in the form of a biconical antenna makes it possible to receive signals in the frequency range of 2.4 to 2.6 GHz with standing wave ratio values of 1.4–1.6. Let us consider the features of the method of processing the received signal in a phase direction finder. After summary processing, the resulting signal is sent to a spectrum analyzer as shown in Figure 4. Estimation of the instantaneous spectrum of a signal can be realized using a discrete or fast Fourier transform (FFT) using statistical averaging (periodogram method) (2)-(7).

To reduce the level of side lobes, weight processing is used (w is the weight function). The algorithm for estimating the instantaneous signal spectrum for the n -th AE has the form (6):

$$S(\theta)_{i,s} = \frac{1}{N_{fft}} \sum_{k=0}^{N_{fft}-1} \left[w_k \xi_{\Sigma} \exp \left(-\frac{j2\pi k i}{N_{fft}} \right) \right] \quad (6)$$

where $floor(\cdot)$ is function of rounding to a smaller integer value; N_{fft} is FFT window size; s is frequency sample number (FFT filter); i is FFT window number. Averaging the instantaneous spectrum in the s -th FFT filter over the time of signal reception by one AE ($T_{A\Theta} = 50$) makes it possible to reduce its dispersion (7):

$$S_{\Sigma}(\theta)_s = \frac{1}{L} \sum_{i=0}^{L-1} S(\theta)_{i,s} \quad (7)$$

where $L = floor\{T_{AE}/(N_{FFT} t_d)\}$ is number of instantaneous spectrum samples of size N_{FFT} when receiving a signal by one AE; t_d is time sampling step. So, for example, with an FFT window size of $N_{FFT} = 64$, a signal reception time off $T_{A\Theta} = 50$, and a sampling time step of ns, the possible number of instantaneous spectrum samples will be $L = 23$. An additional reduction in the variance of the spectrum estimate is provided by using the Welch method, which is one of the nonparametric methods for estimating the power spectrum and has greater accuracy than the Bartlett periodogram method. In the Welch periodogram method, the time sample is divided into overlapping segments (most often by value $N_{\text{on}\Phi}/2$).

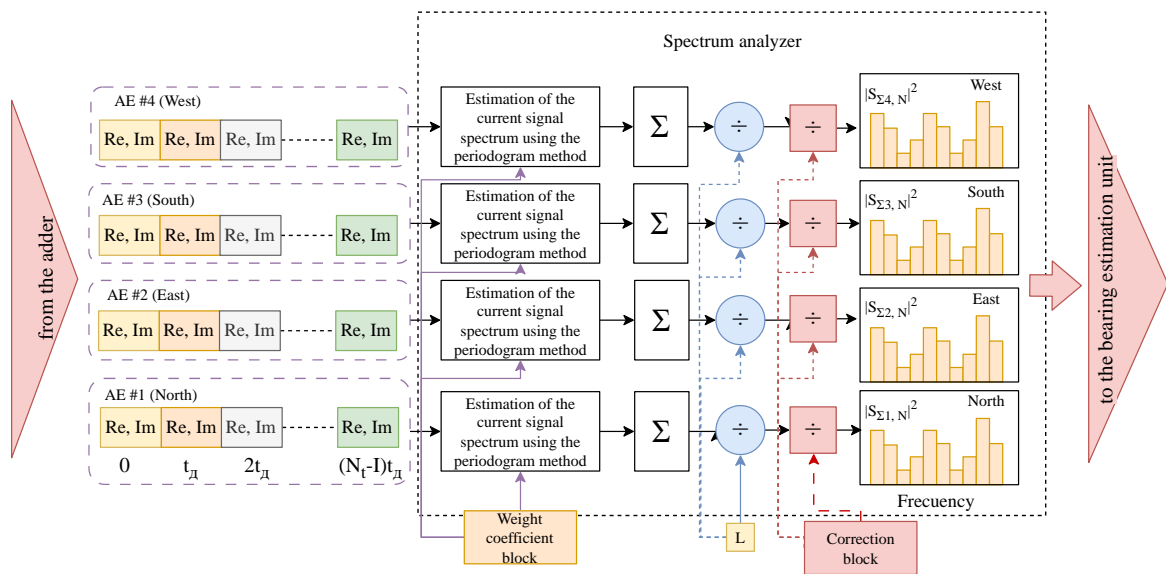

Figure 4. Block diagram of a spectrum analyzer for a two-channel phase radio direction finder

3. RESULTS AND DISCUSSION

Biconical antennas are a phenomenal choice for a variety of applications requiring an omnidirectional radiation pattern and a wide operating frequency band. These antennas are a key component of the antenna system of a two-channel phase direction finder, providing unique signal reception capabilities. One of the key features of biconical antennas is their low directionality. These are specially designed speaker elements that provide the ability to simultaneously receive signals from a wide angular sector. This is a significant advantage in situations where it is necessary to cover a large area and obtain data from different directions. The cardioid beamforming method is another important characteristic. This method eliminates reception of signals from the rear of the antenna system, as well as crosstalk signals. This approach significantly improves system performance and security by minimizing the possibility of interference and interference from unwanted signal sources. The received signal power is estimated by four antenna elements, which transmit data to the bearing estimation unit. This block includes four processing stages, each of which represents an important step in the process of accurately finding the direction of a signal. This integrated approach ensures efficiency and accuracy in a variety of operating conditions, making the system resilient to environmental changes and external influences. The signal direction estimation algorithm is designed to provide high performance in a variety of use cases as shown in Figure 5. This includes the ability to operate in conditions of variable signal strength, varying noise levels and changing environmental characteristics. This adaptive approach ensures stable and reliable operation of the system in various situations. Biconical antennas and their incorporation into a dual channel phase finder antenna system provide a powerful combination of technologies to provide efficient and accurate direction finding of signal direction. Their unique characteristics make them an ideal choice for applications that require broadband operation and omnidirectional sensitivity to signals from multiple directions.

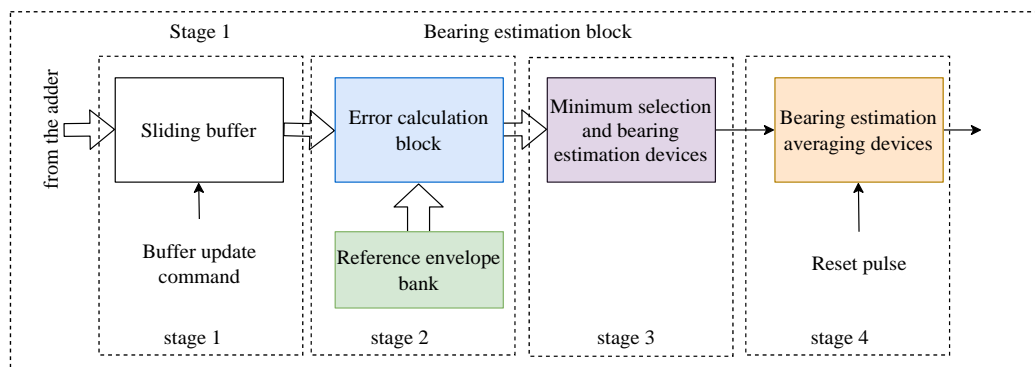

Figure 5. Structure of the bearing estimation block

In the first stage, to expand the number of bearing estimates to an UAV, a sliding buffer is used, as presented in Figure 5. This mechanism provides storage of signal power values received by four antenna elements $S_{\phi_{y\psi}}(\theta)_j = \|S_{\Sigma}(\theta)_1 S_{\Sigma}(\theta)_2 S_{\Sigma}(\theta)_3 S_{\Sigma}(\theta)_4\|$ (where j is the buffer state number) as shown in Figure 6. An innovative idea is to use a moving buffer to store signal strength information over a specific time interval. This approach opens up the possibility of creating time series data, which in turn allows us to more effectively account for the dynamic changes in signals coming from UAVs. This innovative method provides more accurate and reliable estimates of the direction of movement. The operating principle is that signal information is not lost instantly but is stored in a moving buffer for a certain period of time. This creates the ability to analyze data over time, capturing changes in signals over time. This approach is an extremely important element of the bearing estimation method. One of the key advantages of this concept is the ability to adapt to different surveillance scenarios. A moving buffer allows you to effectively take into account the variability of signals from a UAV under various conditions, such as changes in flight altitude, movement speed, and other factors affecting signal characteristics. In addition, the use of a moving buffer provides stability and reliability in estimating the direction of motion even with changing signal dynamics. This is especially important in the context of diverse surveillance scenarios, where conditions may change suddenly and require rapid system adaptation. Thus, the effective use of a moving buffer represents an important step in ensuring the robustness and accuracy of the bearing estimation method for systems dealing with signals from unmanned aerial vehicles. This innovative approach not only improves system efficiency but also ensures reliability in a variety of scenarios and operating conditions.

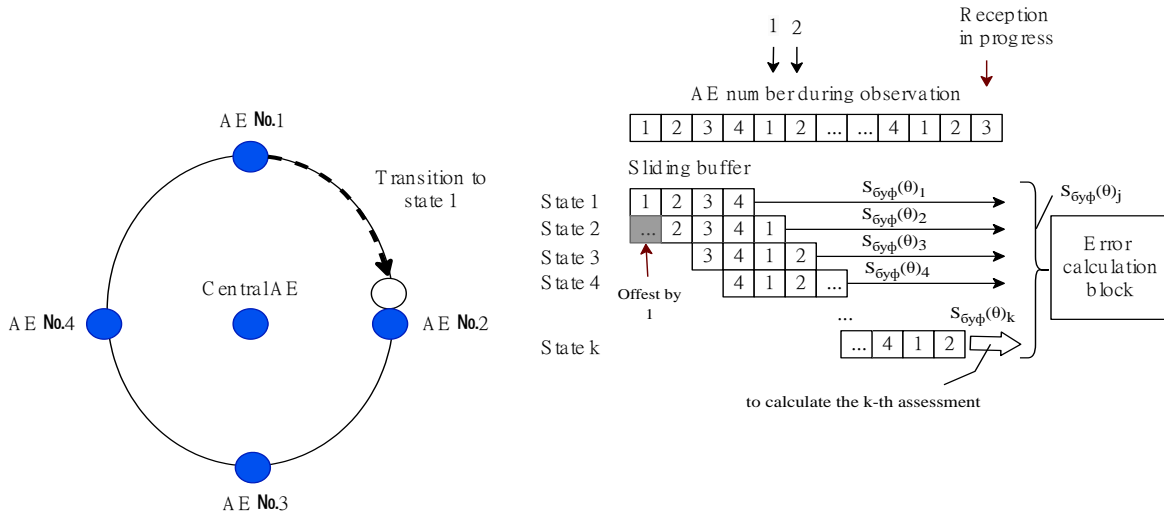

Figure 6. Explanation of the principle of using a sliding buffer

The operating principle of the sliding buffer $S_{FFT}(\theta)_j$ is as follows. After each AE switching, the contents of the buffer are updated (the signal power values are shifted by one cell “to the left” and the new value is written to the far right). So, for example, during the first full revolution of the beam (review cycle), the sliding buffer is filled with estimates of the signal power received by four AEs (state 1 and $j = 1$ ($j = \overline{1, k}$, where is the possible number of buffer states, determined by the observation time of the UAV), Figure 6. As a result, the vector $S_{FFT}(\theta)_1$ is formed, which is used to calculate the first estimate of the bearing on the UAV $\hat{\theta}_1$. When a signal is received by the second AE (state 2 and $j = 2$, Figure 6) the next update is carried out (shifting the buffer data “to the left” and recording a new signal power value). The result of the displacement is the formation of the vector $S_{FFT}(\theta)_2$, which is used to calculate the second estimate of the bearing on the UAV $\hat{\theta}_2$. The procedure continues until the decision is made that there is no UAV (A_0^*). Due to the serial connection of the difference voltage PP to the input circuit of the receiver and the high switching frequency of the AE ($\Omega_A = 5$ kHz), the considered approach allows the generation of at least 5–7 bearing estimates when receiving the UAV control channel signal for a time of $T_{occ} = 500$.

At the second stage, the degree of proximity (mean square error $\delta S(\theta)$) of the envelope of the received signal (output of the sliding buffer $S_{FFT}(\theta)$) to the reference (η_s) is determined by (8), (9), and (10).

$$\delta S(\theta)_{j,k} = \sum_{n=0}^{N_{AE}-1} |S_{\text{fit}}(\theta)_{j,n} - \eta_{s(n \cdot 90, k)}|^2 \tag{8}$$

where $N_{AE} = 4$ – number of AE PP;

$$\eta_{s(q,k)} = 0.25[1 + \cos(q\Delta\theta - \varphi_{0k})]^2 \tag{9}$$

where $\Delta\theta$ is angular direction change step; q is angular direction step number ($q\Delta\theta = (0..360)^\circ$); $\varphi_{0k} = k\Delta\varphi$ is the initial phase of the reference envelope; $k, \Delta\varphi$ is number and step of change of the initial phase, respectively ($k\Delta\varphi = (0..360)^\circ$). At the third stage, a one-time estimate of the bearing on the UAV is assessed (according to the criterion of minimum mean square error, expression (7) by expression (5).

$$\hat{\theta}_j = \arg[\min_k(\delta S(\theta)_{j,k})] \tag{10}$$

where $\min(\cdot)$ is a function of finding the smallest value of a variable. For example, for the example under consideration, the minimum value will correspond to a direction to the UAV equal to it. It should be noted that using a sliding buffer (stage 1) requires bearing adjustments. So, for example, it is necessary to subtract from the second bearing estimate, from the third. In this case, the expression for calculating the one-time direction estimate for the UAV will take the form:

$$\hat{\theta}_{adj j} = \begin{cases} \hat{\theta}_j - 90 \cdot \text{mod}[(j-1), N_{A\Omega}], & \text{if } \hat{\theta}_j \geq 90 \cdot \text{mod}[(j-1), N_{A\Omega}]; \\ \hat{\theta}_j - 90 \cdot \text{mod}[(j-1), N_{A\Omega}] + 360, & \text{if } \hat{\theta}_j < 90 \cdot \text{mod}[(j-1), N_{A\Omega}], \end{cases} \quad (10)$$

where $\text{mod}[\cdot]$ is function for calculating the remainder of division. At the fourth stage, one-time bearing estimates are averaged over the time of contact with the UAV T_n (11):

$$\hat{\theta}_{RS} = \frac{1}{N_{T_n}} \sum_{j=0}^{N_{T_n}-1} \hat{\theta}_{adj j} \quad (11)$$

where N_{T_n} is number of bearing estimates on the UAV received during contact with it T_n . The developed algorithm for determining the direction of UAVs represents a significant achievement in the field of accuracy and efficiency of the direction-finding system. This algorithm allows you to generate bearing estimates with a low standard deviation, not exceeding a value in the range of (3-5) $^\circ$ (depending on test conditions) at a distance of up to 1,000 meters. The obtained values are comparable to the bearing measurement errors in radio direction finders using a four-channel scheme for processing the received signal. This emphasizes the high accuracy of the developed two-channel phase direction finder and its ability to meet the precision guidance requirements of countermeasures against small-sized UAVs. The main disadvantage of the two-channel scheme, compared to the four-channel one, is the higher probability of missing UAV signals with a minimum duration. However, this disadvantage is compensated by the fact that the UAV's radio control and data transmission channel signals are constantly emitted. This solution effectively eliminates the main disadvantage of a two-channel phase direction finder, providing stable and continuous signal perception even with minimal data transmission duration. Thus, a dual-channel direction finder is an effective means for accurately estimating the direction of a UAV, providing high accuracy and stability even in the face of variable signal dynamics. Its ability to reduce the standard deviation of bearing values to (3-5) $^\circ$ at distances up to 1,000 meters highlights its effectiveness in demanding application scenarios.

4. CONCLUSION

This article presents an original contribution to the problem of reducing direction finding errors as part of the development of an algorithm for estimating the direction of a UAV. The proposed algorithm is based on the use of the phase method, which demonstrates high efficiency. By processing the received signal, it was possible to achieve an accurate determination of the direction to the source of radio emission (RES). The solution uses a microwave unit design with minimal complexity and computational load using the LimeSDR radio platform. This platform stands out among other software-defined radio (SDR) projects in terms of efficiency and cost, and also has high RF performance. The LimeSDR architecture, based on the Lime Microsystems LMS7002M radio chip, provides maximum accuracy in the direction-finding process and is open to future functionality improvements, making it a promising platform for further research in the field of radar and direction finding of UAVs. It should be noted that the following conclusions based on the research results: i) the two-channel phase direction finder stands out for its compact and lightweight design, offering a cost-effective alternative to four-channel direction finders with similar functionalities. Its economic advantage is further emphasized by its minimal power consumption requirement, operating efficiently at 5 volts. This achievement is facilitated through the formation of a beam pattern resembling a cardioid shape. The directional information is extracted through sum-difference processing of the received signals, involving sequential switching of the AE. The accuracy of bearing estimates on the UAV is enhanced by employing the periodogram method for signal power estimation. Additionally, a sliding buffer is employed to increase the number of bearing estimates, contributing to a more precise determination of the UAV's direction. In summary, this two-channel phase direction finder offers a compelling combination of compactness, cost-effectiveness, and efficiency in power consumption, making it a promising solution for directional sensing applications on small unmanned platforms; ii) the algorithm for determining the direction to the RES in a two-channel phase direction finder includes 4 stages. At the first stage, the use of a sliding buffer makes it possible to increase the number of bearing estimates from two to 5–7 with a serial connection to the input circuit of the receiver of the differential voltage PP and a high AE switching frequency (kHz) for the minimum possible duration of the radio signal of the UAV control channel μs . At the second stage, the degree of proximity of the received signal envelope to the reference one is determined (expression (7)). At the third stage, a one-time estimate of the bearing on the RES is formed according to the criterion of minimum mean square error (expression (9)). At the fourth stage, one-time estimates of the bearing are averaged over the time of observation of the RES to increase the accuracy of determining its direction (expression (11)); and iii) the algorithm developed for ascertaining the direction to the RES in a two-channel





phase radio direction finder demonstrates remarkable precision. The generated bearing estimates exhibit a standard deviation that, under varying test conditions, does not exceed values typical for distances of up to 1,000 meters. Notably, these achieved results are comparable, if not superior, to the bearing measurement errors observed in radio direction finders equipped with a more complex four-channel received signal processing circuit. This highlights the efficacy of the proposed algorithm in providing accurate directional information, even in conditions where distance is a critical factor. The algorithm's ability to match or surpass the performance of systems with additional channels underscores its efficiency and reliability in practical scenarios, making it a valuable contribution to the field of radio direction finding technology.

REFERENCES





- [1] A. Hegde and D. Ghose, "Multi-UAV collaborative transportation of payloads with obstacle avoidance," *IEEE Control Systems Letters*, vol. 6, pp. 926–931, 2022, doi: 10.1109/LCSYS.2021.3087339.
- [2] D. Pamucar, I. Gokasar, A. Ebadi Torkayesh, M. Deveci, L. Martínez, and Q. Wu, "Prioritization of unmanned aerial vehicles in transportation systems using the integrated stratified fuzzy rough decision-making approach with the Hamacher operator," *Information Sciences*, vol. 622, pp. 374–404, Apr. 2023, doi: 10.1016/j.ins.2022.11.143.
- [3] X. Zhang *et al.*, "Self-triggered based coordinate control with low communication for tethered multi-UAV collaborative transportation," *IEEE Robotics and Automation Letters*, vol. 6, no. 2, pp. 1559–1566, Apr. 2021, doi: 10.1109/LRA.2021.3057294.
- [4] C. A. K. Reddy and B. Venkatesh, "Unmanned aerial vehicle for land mine detection and illegal migration surveillance support in military applications," *Drone Technology: Future Trends and Practical Applications*. Wiley, pp. 325–349, May 2023, doi: 10.1002/97811394168002.ch13.
- [5] S. Shvetsova and A. Shvetsov, "Safety when flying unmanned aerial vehicles at transport infrastructure facilities," *Transportation Research Procedia*, vol. 54, pp. 397–403, 2021, doi: 10.1016/j.trpro.2021.02.086.
- [6] J. Jessin, C. Heinzl, N. Long, and D. Serre, "A systematic review of UAVs for island coastal environment and risk monitoring: towards a resilience assessment," *Drones*, vol. 7, no. 3, Mar. 2023, doi: 10.3390/drones7030206.
- [7] E. Innocenti, G. Agostini, and R. Giuliano, "UAVs for medicine delivery in a smart city using fiducial markers," *Information*, vol. 13, no. 10, Oct. 2022, doi: 10.3390/info13100501.
- [8] R. S. Geronel, G. R. Beghini, R. M. Botez, and D. D. Bueno, "An overview on the use of unmanned aerial vehicles for medical product transportation: flight dynamics and vibration issues," *Journal of the Brazilian Society of Mechanical Sciences and Engineering*, vol. 44, no. 8, Jul. 2022, doi: 10.1007/s40430-022-03644-2.
- [9] S. A. H. Mohsan, M. A. Khan, F. Noor, I. Ullah, and M. H. Alsharif, "Towards the unmanned aerial vehicles (UAVs): a comprehensive review," *Drones*, vol. 6, no. 6, Jun. 2022, doi: 10.3390/drones6060147.
- [10] M. T. Nguyen *et al.*, "Electromagnetic field based WPT technologies for UAVs: a comprehensive survey," *Electronics*, vol. 9, no. 3, Mar. 2020, doi: 10.3390/electronics9030461.
- [11] S. Bharany *et al.*, "A systematic survey on energy-efficient techniques in sustainable cloud computing," *Sustainability*, vol. 14, no. 10, May 2022, doi: 10.3390/su14106256.
- [12] V. P. Babak *et al.*, "Examples of using models and measures on the circle," in *Studies in Systems, Decision and Control*, vol. 360, Springer International Publishing, 2021, pp. 127–156.
- [13] M. A. Jasim, H. Shakhatareh, N. Siasi, A. H. Sawalmeh, A. Aldalbahi, and A. Al-Fuqaha, "A survey on spectrum management for unmanned aerial vehicles (UAVs)," *IEEE Access*, vol. 10, pp. 11443–11499, 2022, doi: 10.1109/ACCESS.2021.3138048.
- [14] I. Catapano, G. Gennarelli, G. Ludeno, C. Noviello, G. Esposito, and F. Soldovieri, "Contactless ground penetrating radar imaging: state of the art, challenges, and microwave tomography-based data processing," *IEEE Geoscience and Remote Sensing Magazine*, vol. 10, no. 1, pp. 251–273, Mar. 2022, doi: 10.1109/MGRS.2021.3082170.
- [15] C. Noviello *et al.*, "An overview on down-looking UAV-based GPR systems," *Remote Sensing*, vol. 14, no. 14, Jul. 2022, doi: 10.3390/rs14143245.
- [16] L. Wang, Y. Chang, and A. Li, "Hydrothermal carbonization for energy-efficient processing of sewage sludge: a review," *Renewable and Sustainable Energy Reviews*, vol. 108, pp. 423–440, Jul. 2019, doi: 10.1016/j.rser.2019.04.011.
- [17] R. Hennequin, A. Khelif, F. Voituret, and M. Moussallam, "Spleeter: a fast and efficient music source separation tool with pre-trained models," *Journal of Open Source Software*, vol. 5, no. 50, Jun. 2020, doi: 10.21105/joss.02154.
- [18] G. Ni, C. He, J. Chen, L. Bai, and R. Jin, "Direction finding and performance analysis with 1 bit time modulated array," *IEEE Transactions on Antennas and Propagation*, vol. 69, no. 10, pp. 6881–6893, Oct. 2021, doi: 10.1109/TAP.2021.3076297.
- [19] N. U. Ain, G. Vaia, W. H. DeLone, and M. Waheed, "Two decades of research on business intelligence system adoption, utilization and success – a systematic literature review," *Decision Support Systems*, vol. 125, Oct. 2019, doi: 10.1016/j.dss.2019.113113.
- [20] J. Boiko, O. Polikarovskiykh, V. Tkachuk, H. Yehoshyna, and L. Karpova, "Design concepts for mobile computing direction finding systems," in *Lecture Notes on Data Engineering and Communications Technologies*, vol. 166, Springer Nature Singapore, 2023, pp. 89–107.
- [21] D. A. Akmaykin, E. A. Bolelov, A. I. Kozlov, B. V. Lezhankin, A. E. Svistunov, and Y. G. Shatrakov, "Goniometric radio navigation systems," in *Springer Aerospace Technology*, Springer Singapore, 2021, pp. 277–310.
- [22] J. Choi *et al.*, "Engineering orthogonal polypeptide GalNAc-transferase and UDP-sugar pairs," *Journal of the American Chemical Society*, vol. 141, no. 34, pp. 13442–13453, Aug. 2019, doi: 10.1021/jacs.9b04695.
- [23] D. Cervettini *et al.*, "Rapid discovery and evolution of orthogonal aminoacyl-tRNA synthetase-tRNA pairs," *Nature Biotechnology*, vol. 38, no. 8, pp. 989–999, Apr. 2020, doi: 10.1038/s41587-020-0479-2.
- [24] A. A. Abdulhameed and Z. Kubík, "Investigation of broadband printed biconical antenna with tapered balun for EMC measurements," *Energies*, vol. 14, no. 13, Jul. 2021, doi: 10.3390/en14134013.
- [25] A. Gupta and X. Fernando, "Simultaneous localization and mapping (SLAM) and data fusion in unmanned aerial vehicles: recent advances and challenges," *Drones*, vol. 6, no. 4, Mar. 2022, doi: 10.3390/drones6040085.

BIOGRAPHIES OF AUTHORS







Indira Kozhabayeva     in 2005 she graduated from the Almaty Institute of Energy and Communications with a degree in automatic telecommunications. In 2014, she graduated from the Humanitarian University of Transport and Law named after D. A. Konaev with a degree in “6M071900 – Radio engineering, electronics and telecommunications” and received a Master of Science degree in technical sciences. Currently she is a 2nd year doctoral student at the Almaty University of Power Engineering and Telecommunication named Gumarbek Daukeev. She is the author of 5 articles in the KOKNVO database. Scientific interests: direction finding estimation algorithms, small-sized unmanned aerial vehicles, antenna systems, mathematical models of antenna pattern formation. She can be contacted at email: ikozhabayeva@mail.ru.







Assel Yerzhan     in 2003, she graduated from the Almaty Institute of Power and Communications with a degree in industrial electronics. In 2004, he received a Master's degree in Radio Electronics and Telecommunications. In 2013, she graduated from the doctoral program “Kazakh National Technical University named after K.I. Satbayev”, specialty 6D071900 - “Radio engineering, electronics and telecommunications”. From 2014 to the present, he has been a Doctor of Philosophy PhD in the specialty 6D071900 - “Radio Engineering, Electronics and Telecommunications” of the Almaty University of Power Engineering and Telecommunication named Gumarbek Daukeev. She is the author of more than 40 works. Her research interests include circuit engineering in telecommunications, wireless communications, mobile communication systems, GSM and mobile systems management, sensor networks, 5G and mobile communication technologies. She can be contacted at email: asel.yerzhan@inbox.ru.







Pavel Boykachev     graduated from “Military Academy of the Republic of Belarus” in 2006 in the specialty “Engineer of radio technical systems”. In 2014, he defended his dissertation in the specialty “Radio engineering, including television systems and devices”. Currently, he is the head of the department of tactics and radio technical troops of “Military Academy of the Republic of Belarus”. He is the author of more than 150 scientific papers. His scientific interests are the theory of adapting radio systems to a wide range of natural operating conditions. He can be contacted at email: pashapasha.boi@mail.ru.





Zhanat Manbetova     in 1999, she graduated from the Korkyt-Ata Kyzylorda State University with a degree in Physics and Additional Mathematics. In 2014, she graduated with a master's degree in “Radio Engineering, Electronics and Telecommunications” from Kazakh Agrotechnical University named after S. Seifullin. In 2022, she defended her doctoral dissertation in the specialty “Radio engineering, electronics and telecommunications”. From 2021 to the present, he is a Doctor of Philosophy Ph.D. of the Department of “Radio Engineering, Electronics and Telecommunications” of the Kazakh Agrotechnical Research University named after S. Seifullin. She is the author of more than 40 works. Her research interests include wireless communications, mobile communication systems, GSM, and mobile systems management, as well as mobile communication technologies. She can be contacted at email: zmanbetova@inbox.ru.





Manat Imankul     in 1979, she graduated from the Tashkent Electrotechnical Institute of Communications with a degree in radio communication and broadcasting. In 1997, she defended her dissertation on the specialty “05.12.13 – Radio and television systems and devices” and received the degree of Candidate of Technical Sciences. Currently, she is an associate professor of the Department of Radio Engineering, Electronics and Telecommunications of the L.N. Gumilyov Eurasian National University. She is the author of more than 200 scientific papers, including 1 monograph, 2 articles in the Scopus database. Her research interests include wireless communication technologies. She can be contacted at email: mimankul57@gmail.com.





Builou Yauheni    graduated from the higher educational institution Military Academy of the Republic of Belarus in 2008 with a degree in engineer. Management Specialist. In 2022, he defended his dissertation in the specialty 05.12.14 – radar and radio navigation and received the degree of Candidate of Technical Sciences. Currently, he is a leading employee of the scientific research part of the education Military Academy of the Republic of Belarus. In total, he is the author of more than 80 scientific papers. Scientific interests: broadband signals, broadband coordinate meters, signal processing in electronic intelligence equipment. He can be contacted at email: lerka.by@mail.ru.



Andrey Solonar    graduated from the Military Academy of the Republic of Belarus in 1998 with a degree in radio engineering. In 2005, he defended his dissertation in the specialty 05.12.02 – Radio engineering, including television systems and devices and received the academic degree of Candidate of Technical Sciences. In 2009, he received the academic title of associate professor in the specialty: radio engineering and communications. Currently, he is a leading researcher at JSC KB Radar. He is the author of 66 articles in peer-reviewed scientific publications, including 6 articles in the Scopus database. Scientific interests: processing of received signals in radar systems, analysis of radar information, trajectory processing of data from radars and optical-location systems. He can be contacted at email: andssnew@yandex.ru.



Pavel Dunayev    in 2000, he graduated from the Kazakh State Agrotechnical University named after S. Seifullin with a degree in automatic telecommunication. In 2018, he defended his dissertation on the specialty “051213 - Telecommunications systems, networks and devices” and received the degree of Candidate of Technical Sciences. In 2021, he received a Ph.D. degree in the specialty “6D071900 - Radio engineering, electronics and telecommunications”. Currently, he is an acting associate professor, Head of the Department of Radio Engineering, Electronics and Telecommunications at the Kazakh Agrotechnical Research University named after S. Seifullin. He is the author of more than 50 scientific papers, including 1 monograph, 7 articles in the Scopus database. His research interests include digital television, telecommunication network bandwidth, fiber-optic communication lines. He can be contacted at email: dunayev.kz@mail.ru.